

**SERIES SMB-75
RF COAXIAL CONNECTORS**

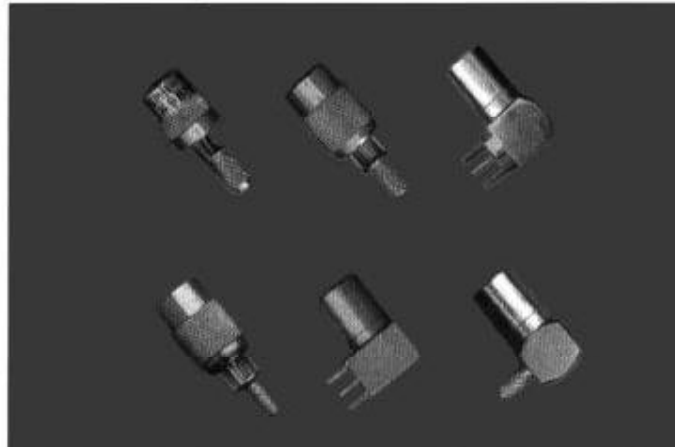

Key performance

- Characteristic impedance: 75 Ω
- Frequency range: 0~2GHz
- Contact resistance:
 - Center conductor: ≤6.0m Ω
 - Out conductor : ≤1.0m Ω
- Insulation resistance : ≥1000M Ω
- Insulator voltage withstanding : 750V
- VSWR : ≤1.30
- Connector durability : 500 cycles
- Applicable spec/std: MIL-C-39012

Material

- Center contacts:
 - Male---brass, gold plated.
 - Female---beryllium copper, gold plated
- Bodies and other metal parts:
 - brass, gold plated
- Insulators: Teflon
- Crimp ferrule: copper, nickel plated.
- Gasket and seal rings: silicone rubber
- Heat-shrink tubing: thermofit plastic.

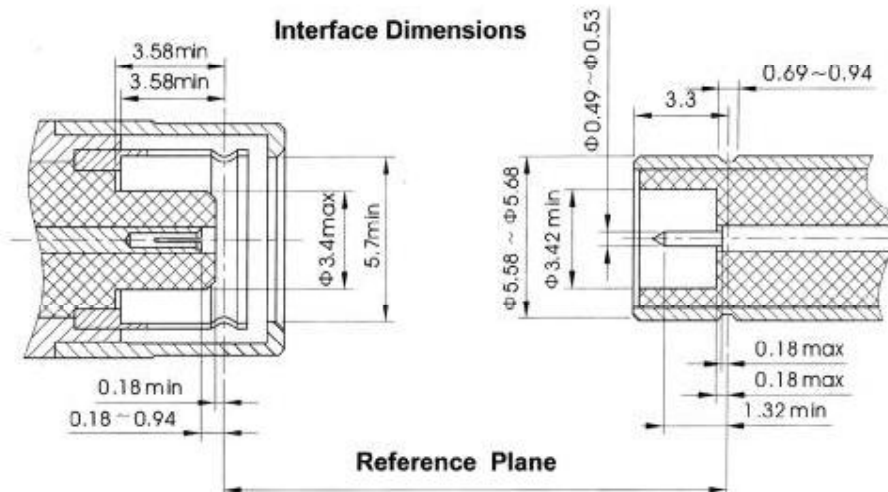

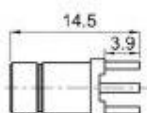

mounting hole

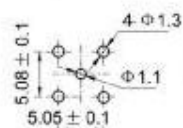

Type	part number
SMB-75JHD	5010-5800

Note

SMB-75JHD 5010-5800

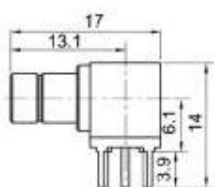

mounting hole

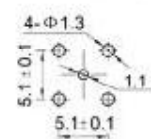

Type	part number
SMB-75JWHD	5030-5800

Note

SMB-75JWHD 5030-5800

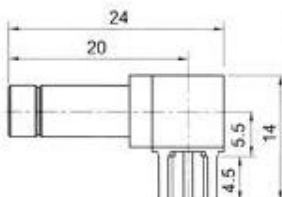

mounting hole

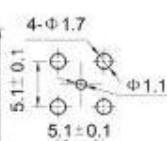

Type	part number
SMB-75JWHD1	5030-5802

Note

SMB-75JWHD1 5030-5802

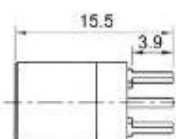

mounting hole

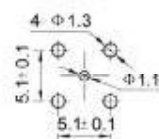

Type	part number
SMB-75KHD	5020-5800

Note

SMB-75KHD 5020-5800

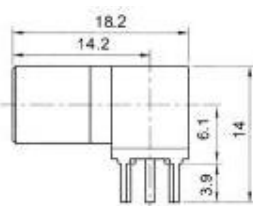

mounting hole

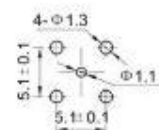

Type	part number
SMB-75KWHD	5040-5800

Note

SMB-75KWHD 5040-5800

SMB-75 SERIES

CERNEXWAVE

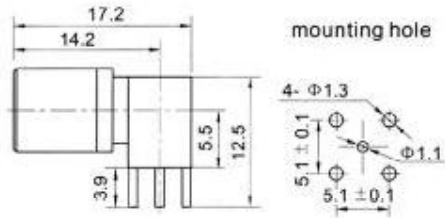

Type	part number	Note
------	-------------	------

SMB-75KWHDA	5040-5301	
-------------	-----------	--

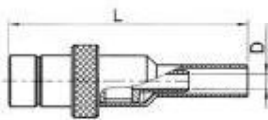

Type	part number	suitable cable	L	D	Note
------	-------------	----------------	---	---	------

SMB-75J2.5C	5010-6501	3	26.5	Ø1.65	
-------------	-----------	---	------	-------	--

SMB-75J4	5010-6504	4	26.2	Ø2.2	
----------	-----------	---	------	------	--

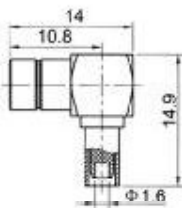

Type	part number	suitable cable	Note
------	-------------	----------------	------

SMB-75JW3	5030-6500	3	
-----------	-----------	---	--



Type	part number	suitable cable	Note
------	-------------	----------------	------

SMB-75JW12	5030-6500	12	
------------	-----------	----	--

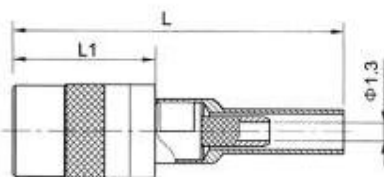

Type	part number	suitable cable	L	L1	Note
------	-------------	----------------	---	----	------

SMB-75K3	5020-6504	3	24.2	10.2	crimp ferrule, nickel plated
----------	-----------	---	------	------	------------------------------

SMB-75K3A	5020-6513	3	26.7	9.7	crimp ferrule, gold plated
-----------	-----------	---	------	-----	----------------------------

SMB-75 SERIES

CERNEXWAVE

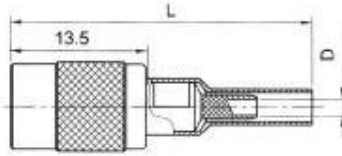

Type	part number	suitable cable	L	D	Note
SMB-75K2.5C	5020-6502	3	29.6	Φ1.6	crimp ferrule, gold plated
SMB-75K4C	5020-6507	4	29.2	Φ2.2	crimp ferrule, gold plated

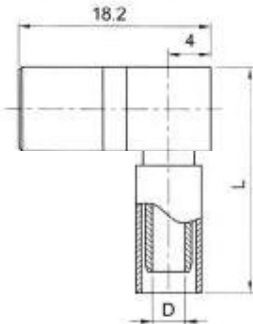

Type	part number	suitable cable	L	D	Note
SMB-75KW3	5040-6502	3	15.9	Φ1.6	crimp ferrule, nickel plated
SMB-75KW4D	5040-6503	4	19.4	Φ2.2	crimp ferrule, nickel plated
SMB-75KW12	5040-6504	12	21.4	Φ3.1	crimp ferrule, nickel plated

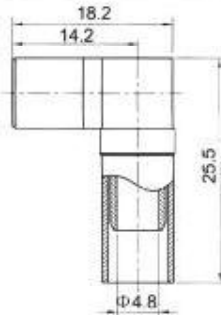

Type	part number	suitable cable	Note
SMB-75KW13	5040-6500	13	crimp ferrule, nickel plated

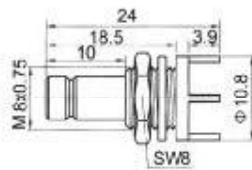

mounting hole

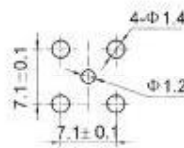

Type	part number	Note
SMB-75JYHD	5010-7800	

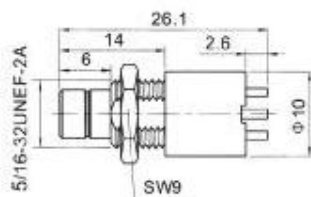

mounting hole

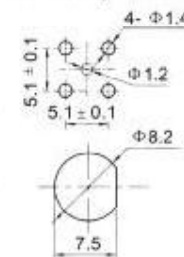

Type	part number	Note
SMB-75JYHD1	5010-7801	

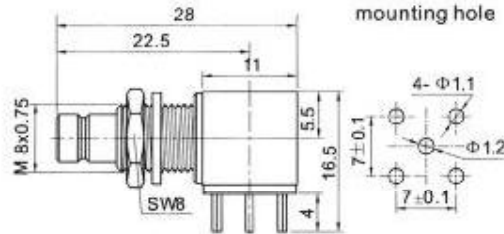

Type	part number	Note
SMB-75JYWHD	5030-7803	

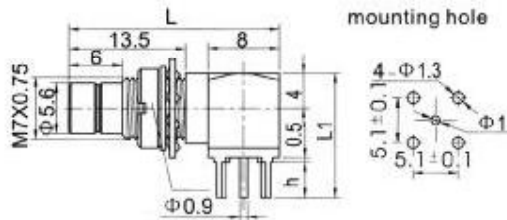

Type	part number	L	L1	Note
SMB-75JYWHD1	5030-7800	24	14	
SMB-75JYWHD2	5030-7801	33	27.5	
SMB-75JYWHD3	5030-7802	24	19	double washer washer nickel plated

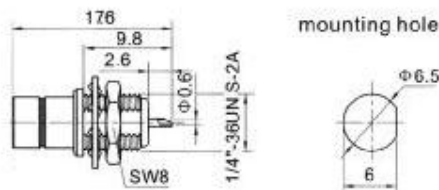

Type	part number	Note
SMB-75JY	5010-2900	

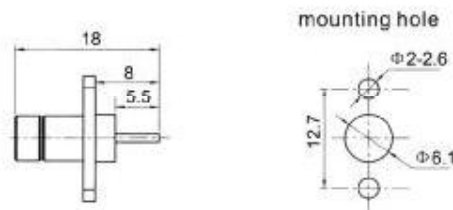

Type	part number	Note
SMB-75JFD	5010-0000	

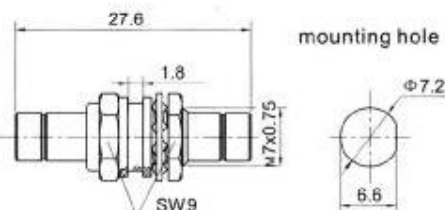

Type	part number	Note
SMB-75JJY	5000-2900	with dustproof cap