

**SERIES BNC-75
RF COAXIAL CONNECTORS**

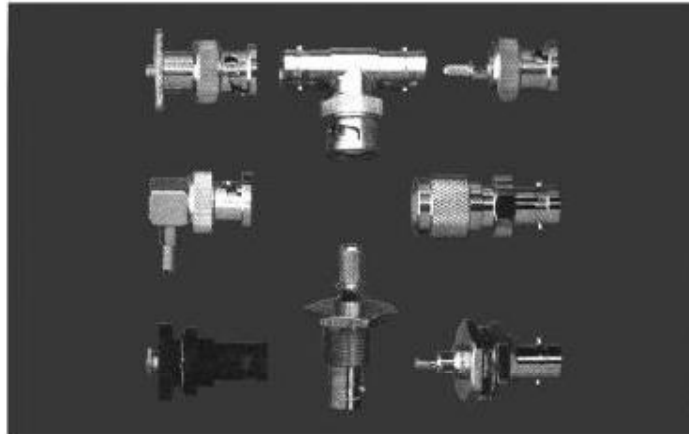

Key performance

Characteristic Impedance : 75 Ω
 Frequency range : 0~2GHz
 Contact resistance :
 Center conductor ≤2.0m Ω
 Out conductor ≤0.2m Ω
 Insulation resistance : ≥5000M Ω
 Insulator voltage withstanding : 1500V
 VSWR : ≤1.30
 Connector durability : 500 cycles
Applicable spec/std : MIL-C-39012

Material

Center contacts:
 Male---brass, gold plated.
 Female---phosphor bronze, gold plated
 Bodies and other metal parts:
 brass, nickel plated
 Insulators: Teflon
 Crimp ferrule: copper, nickel plated.
 Gasket and seal rings: silicone rubber
 Heat-shrink tubing: thermofit plastic.

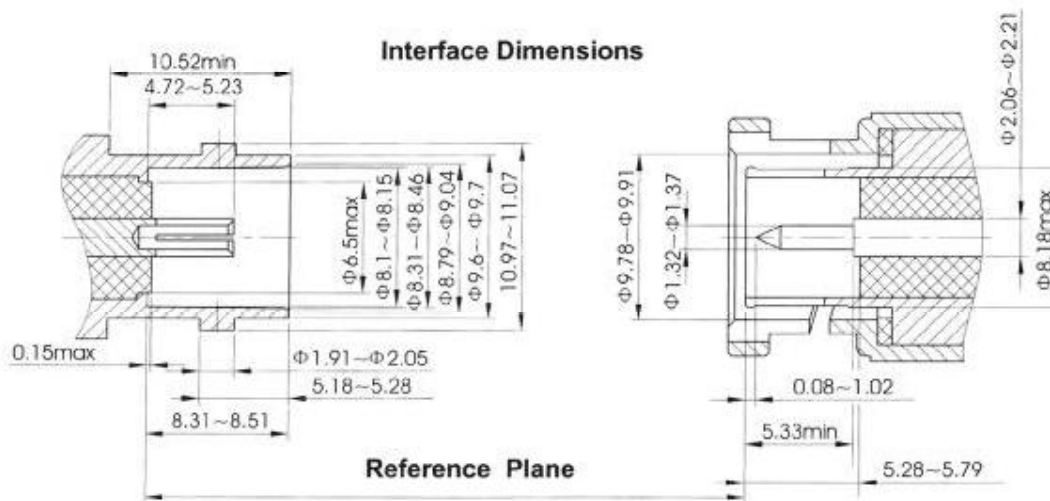

BNC-75 SERIES

CERNEXWAVE

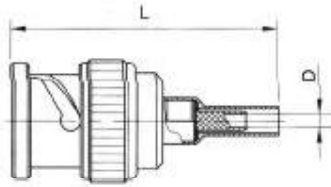

Type	part number	suitable cable	L	D	Note
BNC-75J25C	5411-6510	3	32.3	Φ1.6	
BNC-75J3Y	5411-6502	3	29.5	Φ1.6	
BNC-75J4Y	5411-6503	4	31.3	Φ2.3	
BNC-75J201C	5411-6511	201	33.3	Φ3.8	
BNC-75J616YA	5411-6513	616	33.8	Φ5.3	

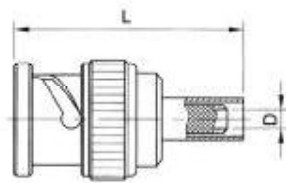

Type	part number	suitable cable	L	D	Note
BNC-75J4YA	5411-6504	4	25.8	Φ2.3	
BNC-75J4YB	5411-6505	4A	25.8	Φ2.3	
BNC-75J4YC	5411-6506	4	28.5	Φ2.5	
BNC-75J616Y	5411-6512	616	37.1	Φ5.3	

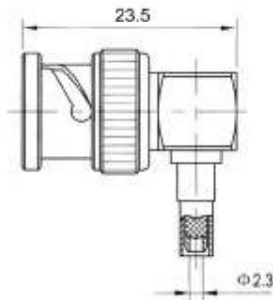

Type	part number	suitable cable	Note
BNC-75JW4Y	5431-6503	4	
BNC-75JW4YA	5431-6504	4A	

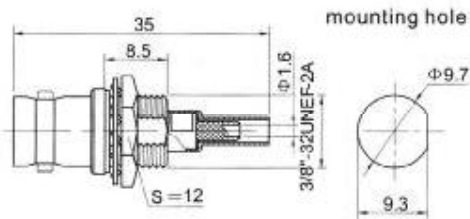

Type	part number	suitable cable	Note
BNC-75KY3Y	5421-2502	3	

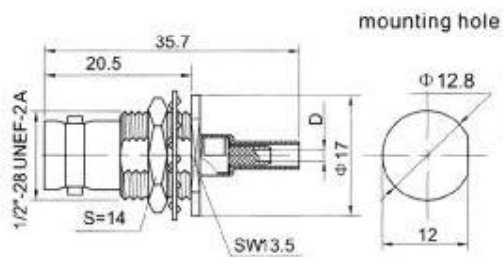

Type	part number	suitable cable	D	Note
BNC-75KY3YA	5421-2504	3	Φ1.6	
BNC-75KY4YA	5421-2507	4	Φ2	

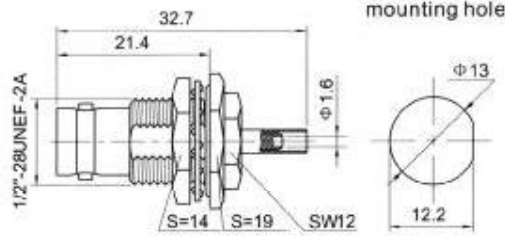

Type	part number	suitable cable	Note
BNC-75KY3YB	5421-2505	3	

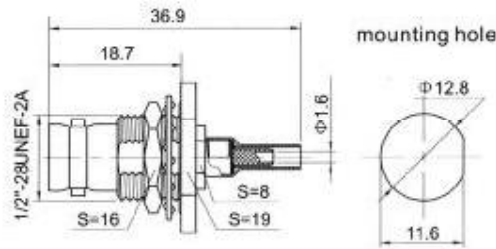

Type	part number	suitable cable	Note
BNC-75KY3YC	5421-2506	3	

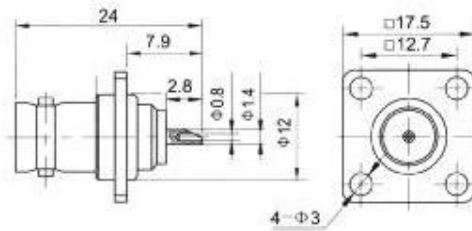

Type	part number	Note
BNC-75KF	5421-1900	

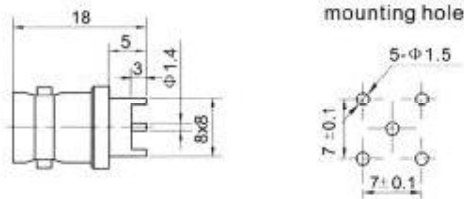

Type	part number	Note
BNC-75KHD	5421-5800	

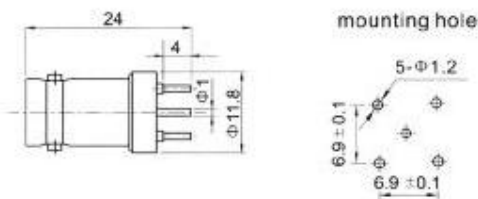

Type	part number	Note
BNC-75KHD1	5421-5801	

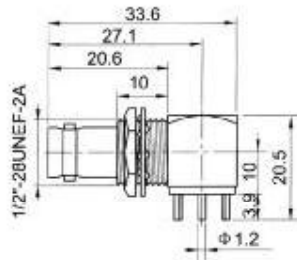

mounting hole

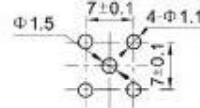

Type	part number	Note
BNC-75KYWHD	5441-7800	

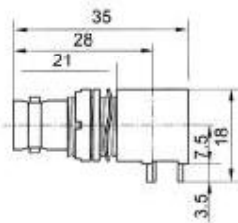

mounting hole

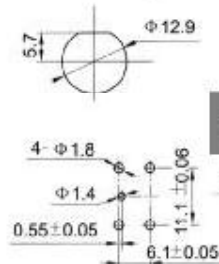

Type	part number	Note
BNC-75KYWHD1	5441-7801	

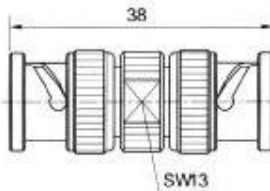

Type	part number	Note
BNC-75JJ	5401-6900	

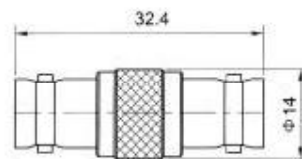

Type	part number	Note
BNC-75KK	5401-8901	

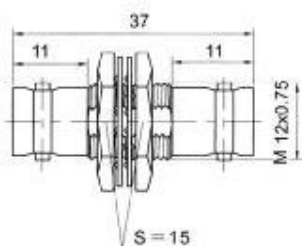

mounting hole

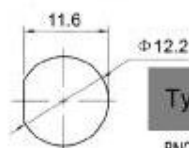

Type	part number	Note
BNC-75KKY	5401-1900	