

**SURFACE MOUNT RF
COAXIAL CONNECTORS**

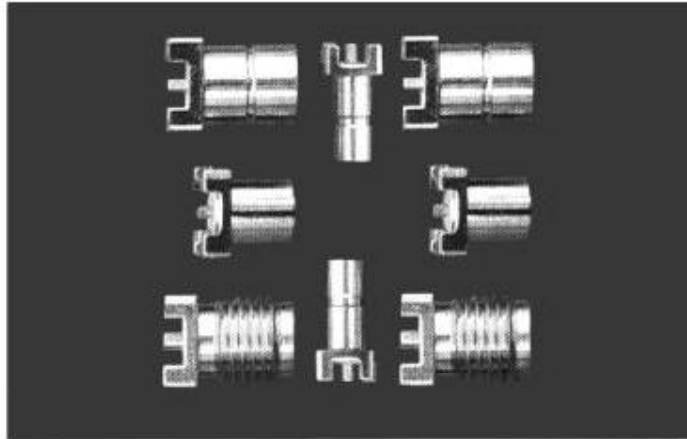

Surface mount connectors are attached to the circuit board by soldering but not in the same fashion as the through hole mount of the PCB connector. These units are attached to pads on the board by means of a solder reflow process. This eliminates the need for drilled holes and reduces the overall installation. CERNEXWAVE offers surface mount connectors in series SMA, SMB, SMC, MCX, SSMB, and MMCX.

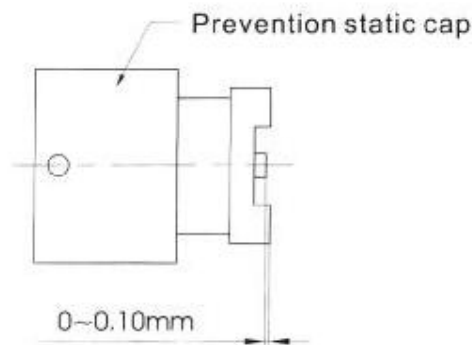
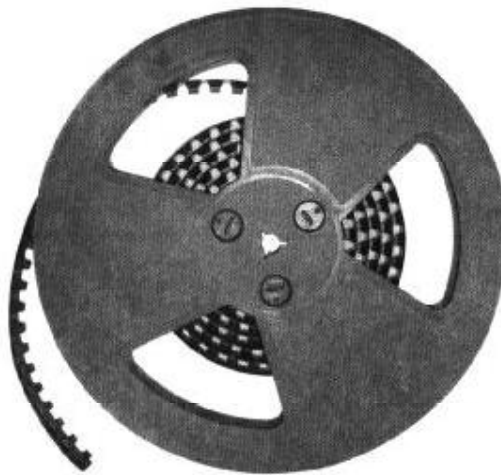

SURFACE MOUNT SERIES

CERNEXWAVE

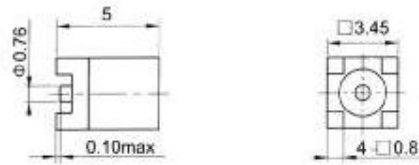

Type	part number	Note
MMCX-KHT	1520-4801	

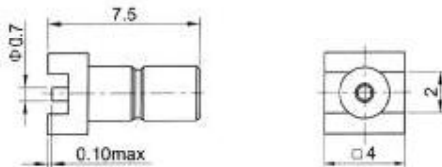

Type	part number	Note
SSMB-JHT	1010-4801	

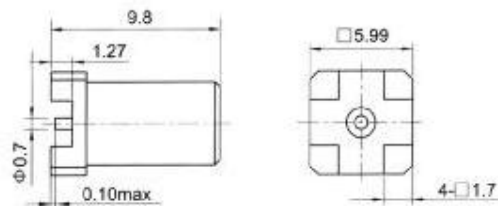

Type	part number	Note
SSMB-KHT	1020-4801	

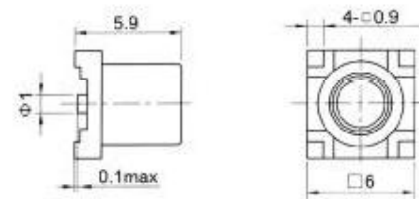

Type	part number	Note
MCX-KHT	0020-4801	

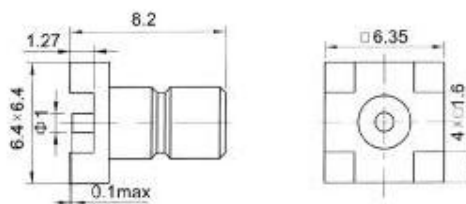

Type	part number	Note
SMB-JHT	0410-4801	

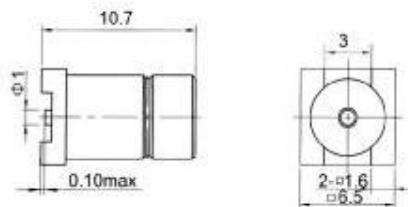

Type	part number	Note
------	-------------	------

SMA-KWHT	0340-4801	
----------	-----------	--



Type	part number	Note
------	-------------	------

SMC-JHT	0510-4801	
---------	-----------	--

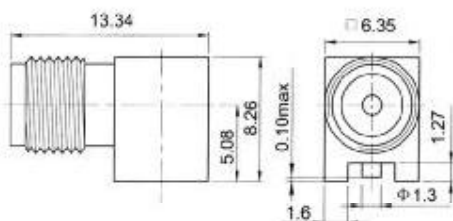

Type	part number	Note
------	-------------	------

SMA-KWHT	0340-4801	
----------	-----------	--