

**SERIES SMB
RF COAXIAL CONNECTORS**



SMB connectors manufactured by CERNEXWAVE are designed specially to ensure fast reliable connection. The SMB coaxial connector is recommended for applications with high packing density.

Key performance

- Characteristic impedance: 50 Ω
- Ferquency range:
 - With flexible cable: 0~12.4GHz
 - With semi-rigid/comfortable cable: 0~18GHz
- Contact resistance:
 - center conductor : ≤3.0m Ω
 - out conductor : ≤2.0m Ω
- Insulation resistance : ≥5000M Ω
- Insulator voltage withstanding : 1000V
- VSWR : with flexiabile cable :
 - ≤1.15+0.02f
 - with semi-rigid/flexiabile cable:
 - ≤1.10+0.01f
- Connector durability : 500

Applicable spec/std: MIL-C-39012

Material

- Center contacts:
 - Male---brass, gold plated.
 - Female---beryllium copper, gold plated
- Bodies other metal parts:
 - brass, gold plated
- Insulators: Teflon
- Crimp ferrule: copper, nickel plated.
- Gasket and seal rings: silicone rubber
- Heat-shrink tubing: thermofit plastic.
- For passivated stainless steel versions, add "G" after the P/N.

Interface Dimensions

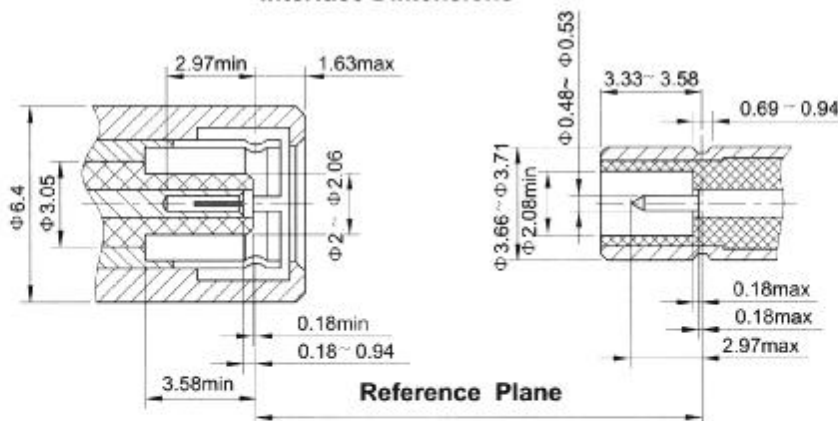

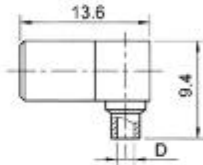

Type part number suitable cable D Note

SMB-KWB1	0440-6601	B1	Φ1.3	matching outer contact
SMB-KWB2	0440-6602	B2	Φ2.2	
SMB-KWB3	0440-6603	B3	Φ3.6	

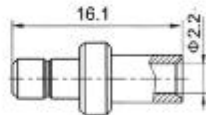

Type part number suitable cable Note

SMB-JB2	0410-6601	B2		
---------	-----------	----	--	--

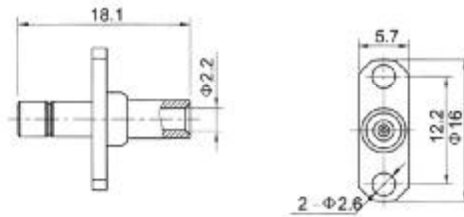

Type part number suitable cable Note

SMB-JFB2	0410-1601	B2		
----------	-----------	----	--	--

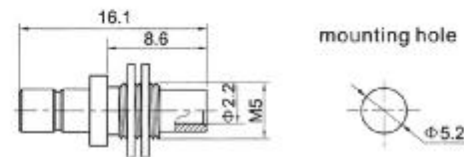

Type part number suitable cable Note

SMB-JVB2	0410-2601	B2		
----------	-----------	----	--	--



Type part number suitable cable Note

SMB-KWB2N	0440-6604	B2		nickel plated matching outer contact
-----------	-----------	----	--	--------------------------------------

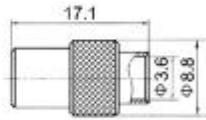

Type	part number	suitabe cable	Note
SMB-KB3	0420-6601	83	

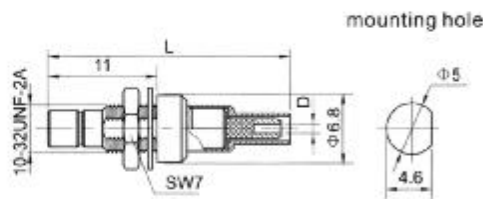

Type	part number	suitabe cable	L	D	Note
SMB-JY2	0410-2501	2	24	Φ0.9	
SMB-JY3-1	0410-2504	3	27.3	Φ1.6	

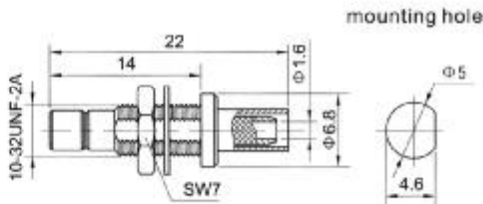

Type	part number	suitabe cable	Note
SMB-JY3	0410-2503	3	

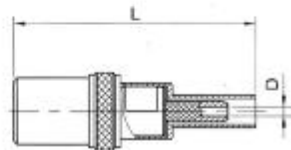

Type	part number	suitabe cable	L	D	Note
SMB-K2	0420-6501	2	23.2	Φ0.9	
SMB-K3	0420-6502	3	22.7	Φ1.6	
SMB-K3-B	0420-6504	3	24.2	Φ1.6	
SMB-K3C	0420-6506	3	33	Φ1.6	matching outer contact
SMB-K4	0420-6507	4	21	Φ2.3	
SMB-K5	0420-6508	5	26.2	Φ3.1	

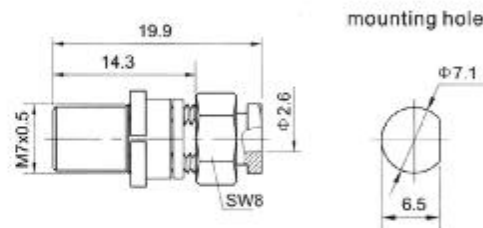

Type	part number	suitabe cable	Note
SMB-KY2	0420-2502	2	

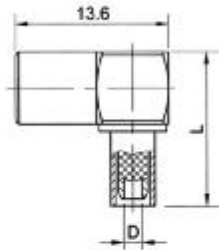

Type	part number	suitable cable	L	D	Note
SMB-KW2	0440-6501	2	13.7	Φ0.9	
SMB-KW2A	0440-6502	2	13.7	Φ0.9	matching outer contact
SMB-KW3	0440-6503	3	13.1	Φ1.6	
SMB-KW3A-1	0440-6505	3	14.3	Φ1.6	matching outer contact
SMB-KW3C	0440-6507	3A	16.2	Φ1.6	matching outer contact
SMB-KW4	0440-6508	4	15.8	Φ2.3	
SMB-KW5	0440-6504	5	19.8	Φ3.1	

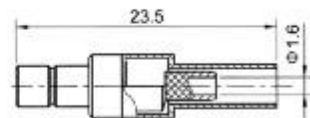

Type	part number	suitable cable	Note
SMB-J3	0410-6501	3	

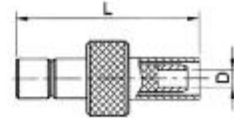

Type	part number	suitable cable	L	D	Note
SMB-J3A	0410-6502	3	16.4	Φ1.6	
SMB-J5A	0410-6503	5	25.5	Φ3.1	

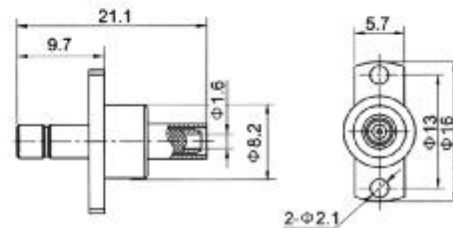

Type	part number	suitable cable	Note
SMB-JF3A	0410-0002	3	

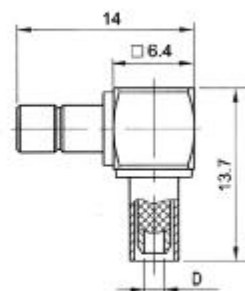

Type	part number	suitable cable	D	Note
SMB-JW2	0430-6501	2	Φ0.9	
SMB-JW3	0430-6502	3	Φ1.6	
SMB-JW4	0430-6503	4	Φ2.3	

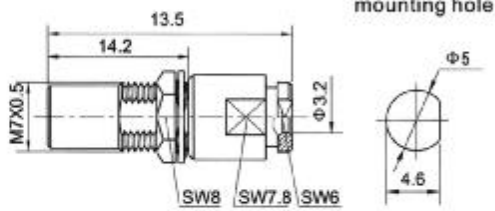

Type	part number	suitable cable	Note
SMB-KY3A	0420-2504	3	

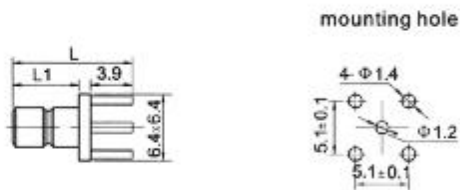

Type	part number	L	L1	Note
SMB-JHD	0410-5801	11.4	6.3	
SMB-JHDA	0410-5808	10.7	5.6	
SMB-JHD3	0410-5804	18.3	13.2	
SMB-JHD4	0410-5805	13.7	8.6	
SMB-JHD5	0410-5806	9.9	5.2	

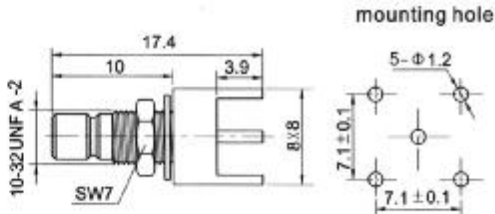

Type	part number	Note
SMB-JHD1	0410-5802	

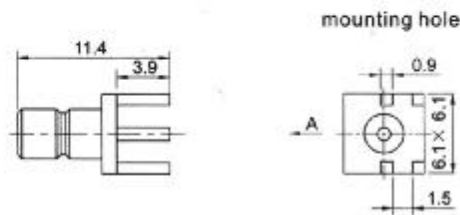
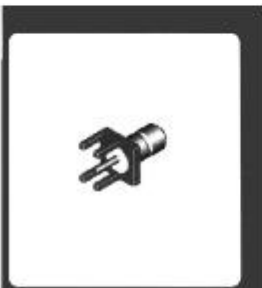

Type	part number	Note
SMB-JHD2	0410-5803	

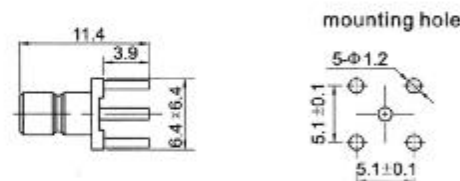

Type	part number	Note
SMB-JHD6	0410-5807	

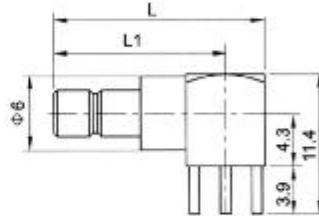

mounting hole

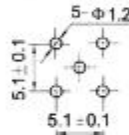

Type	part number	L	L1	Note
SMB-JWHD	0430-5801	15.5	12.3	
SMB-JWHD1	0430-5802	21.6	18.4	
SMB-JWHD2	0430-5803	13.7	10.5	
SMB-JWHD10	0430-5804	15.5	12.3	

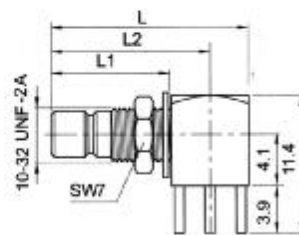

mounting hole

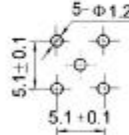

Type	part number	L	L1	L2	Note
SMB-JWHY	0430-7901	17.9	11.5	14.7	
SMB-JWHY1	0430-7902	21.6	15.2	18.4	
SMB-JWHY2	0430-7903	21.6	15.2	18.4	with double nut

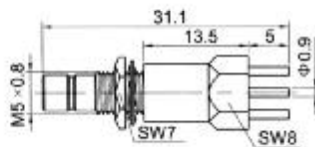

mounting hole

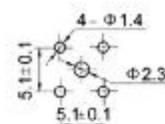

Type	part number	Note
SMB-JYHD	0410-7801	

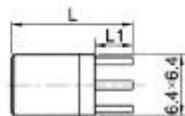

mounting hole

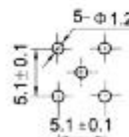

Type	part number	L	L1	Note
SMB-KHD	0420-5801	12.5	3.9	
SMB-KHD1	0420-5802	21.5	2.9	

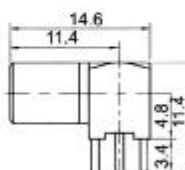

mounting hole

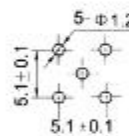

Type	part number	Note
SMB-KWHD	0440-5801	
SMB-KWHDCA	0440-5802	with protection cap

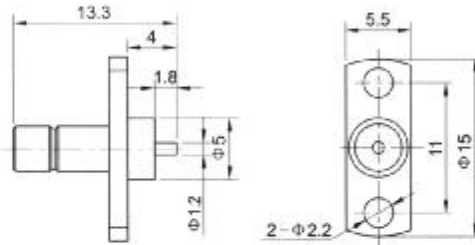

Type	part number	Note
------	-------------	------

SMB-JFD 0410-0001

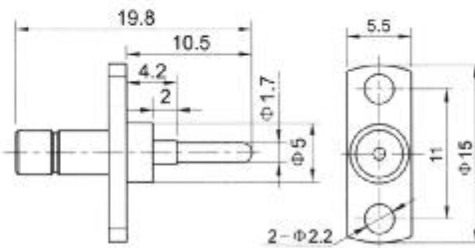

Type	part number	Note
------	-------------	------

SMB-JFD3 0410-0002

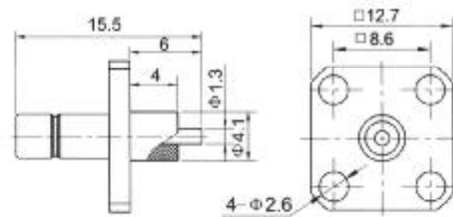

Type	part number	Note
------	-------------	------

SMB-JFD21 0410-0002

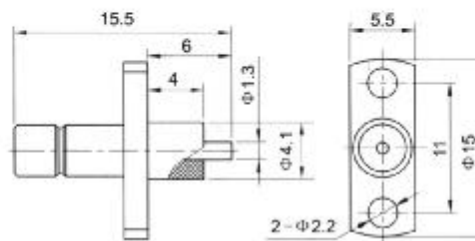

Type	part number	Note
------	-------------	------

SMB-JFD21A 0420-0002

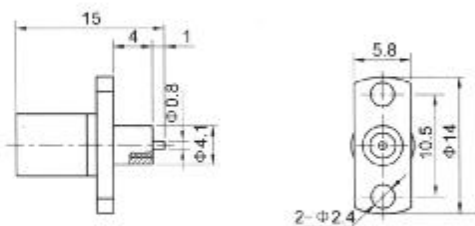

Type	part number	Note
------	-------------	------

SMB-KFDA 0420-0001

matching
outer contact

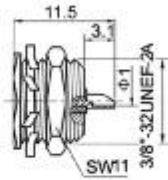

mounting hole



Type	part number	Note
SMB-JYA	0410-2901	

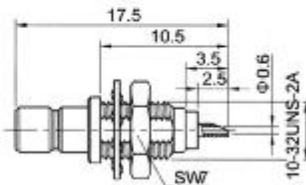

mounting hole

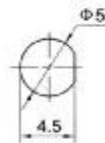

Type	part number	Note
SMB-JYD	0410-2801	

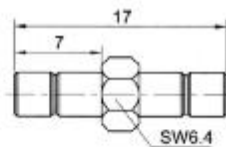

Type	part number	Note
SMB-JJ	0400-6901	

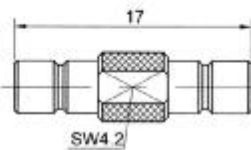

Type	part number	Note
SMB-JJA	0400-6902	

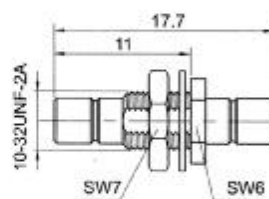

mounting hole

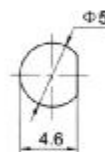

Type	part number	Note
SMB-JJY	0400-2901	

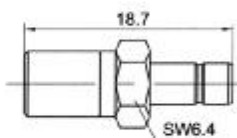

Type	part number	Note
SMB-KJ	0400-6903	

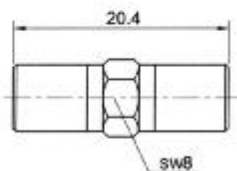

Type	part number	Note
SMB-KK	0400-6904	