

**SERIES SAA-75
RF COAXIAL CONNECTORS**

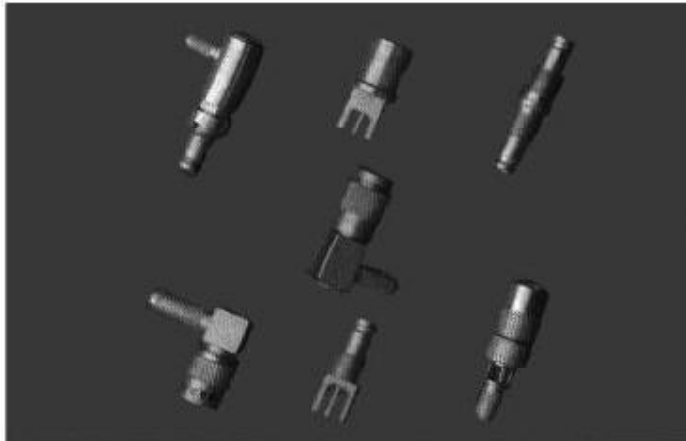

Series SAA-75 is super small style RF coaxial connector, in common use construction contain push-pull self-latching style and screw-coupling style. The advantages are connection convenience, reliable connection and vibration resistance etc.

Key performance

- Characteristic impedance: 75 Ω
- Frequency range: 0~1GHz
- Contact resistance:
 - Center conductor : ≤ 10.0m Ω
 - Out conductor : ≤ 3.0 m Ω
- Insulation resistance : ≥ 1000M Ω
- Insulator voltage withstanding : 750V
- VSWR : ≤ 1.30
- Connector durability : 500

Applicable spec/std: DIN47297

Material

- Center contacts:
 - Male---brass, gold plated.
 - Female---beryllium copper, gold plated
- Bodies and other metal parts:
 - brass, gold plated
- Insulators: Teflon
- Crimp ferrule: copper, nickel plated.
- Gasket and seal rings: silicone rubber
- Heat-shrink tubing: thermofit plastic.

Interface Dimensions

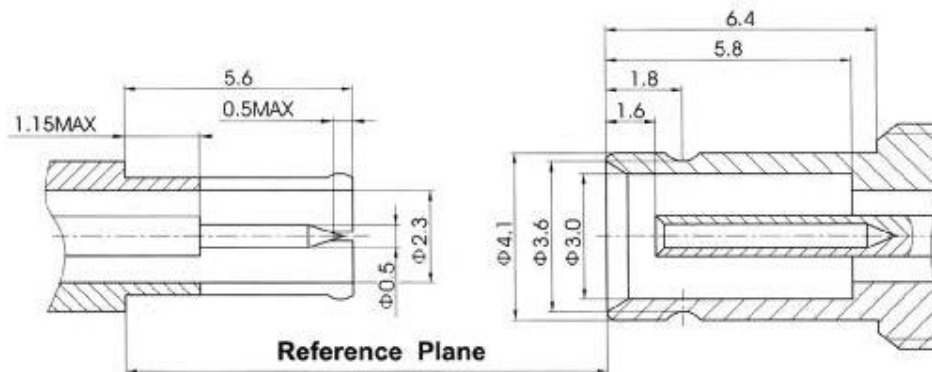

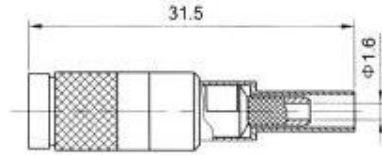

Type part number suitable cable Note

SAA-75J32 5211-6501 32

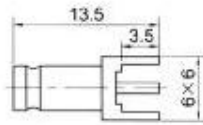

mounting hole

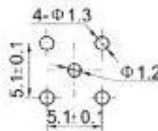

Type part number Note

SAA-75KHD 5200-5800

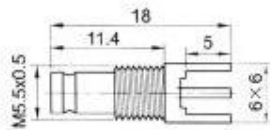

mounting hole

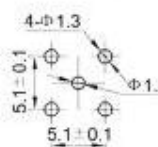

Type part number Note

SAA-75KHD1 5200-5801

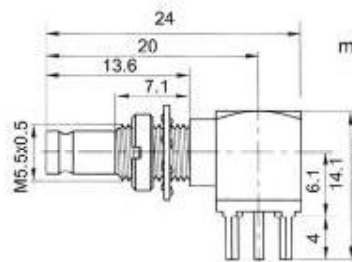

mounting hole

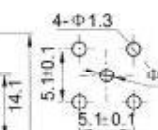

Type part number Note

SAA-75KYWHD2 5240-7801

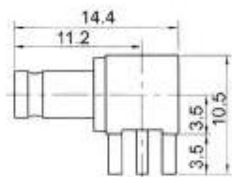

mounting hole

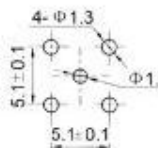

Type part number Note

SAA-75KWHD 5240-5800

Series SAA - 75 RF coaxial connector with screw

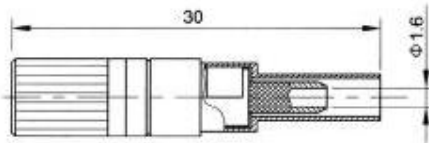

Type	part number	suitable cable	Note
------	-------------	----------------	------

SAA-L75J3	5211-6501	3	
-----------	-----------	---	--

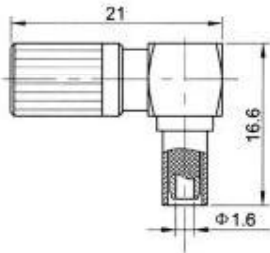

Type	part number	suitable cable	Note
------	-------------	----------------	------

SAA-L75JW3	5231-6501	3	
------------	-----------	---	--

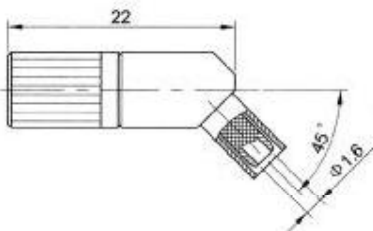

Type	part number	suitable cable	Note
------	-------------	----------------	------

SAA-L75/W3A	5231-6502	3	
-------------	-----------	---	--