

**SERIES BNC  
RF COAXIAL CONNECTORS**



BNC series feature a two stud, bayonet coupling, which is engaged by rotating the sleeve less than 1/2 turn, BNC connectors are recommended for use at frequency up to 4 GHz where repeated coupling and uncoupling are anticipated.

**Key performance**

- Characteristic Impedance : 50 Ω
- Frequency range : 0~4GHz
- Contact resistance :
  - Center conductor ≤ 2.0m Ω
  - Out conductor ≤ 0.2m Ω
- Insulation resistance : ≥ 5000M Ω
- Insulator voltage withstanding : 1500V
- VSWR : ≤ 1.30
- Connector durability : 500 cycles

**Material**

- Center contacts:
  - Male---brass, gold plated.
  - Female---beryllium copper, gold plated
- Bodies other metal parts:
  - brass, gold plated
- Insulators: Teflon
- Crimp ferrule: copper, nickel plated.
- Gasket and seal rings: silicone rubber
- Heat-shrink tubing: thermofit plastic.

**Applicable spec/std : GJB681A ( MIL-C-39012 )**

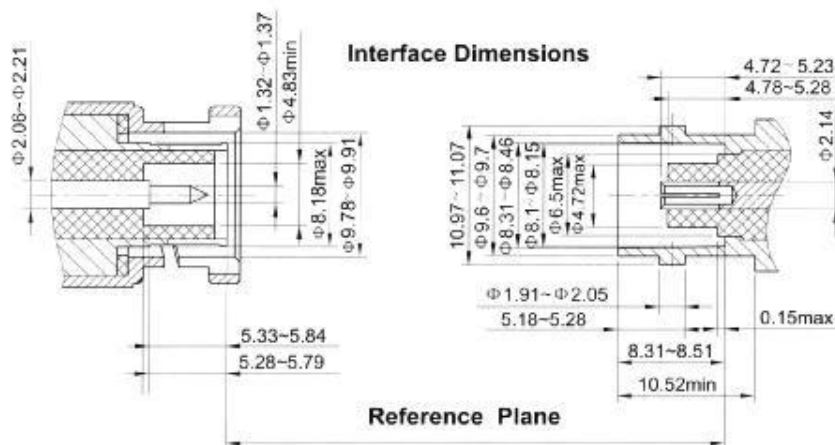

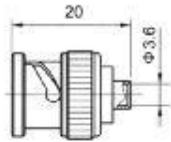

Type part number suitable cable Note

BNC-JB3	0811-6601	B3	
---------	-----------	----	--

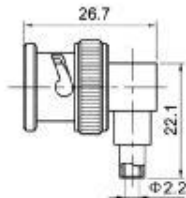

Type part number suitable cable Note

BNC-JWB2	0831-6601	B2	
----------	-----------	----	--

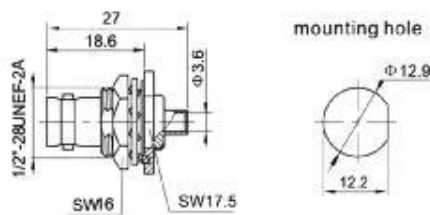

Type part number suitable cable Note

BNC-KYB3	0821-2602	B3	
----------	-----------	----	--

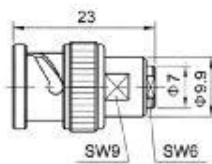

Type part number suitable cable Note

BNC-J3	0811-6512	3	
--------	-----------	---	--

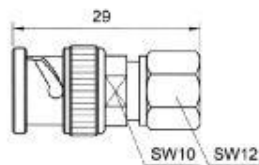

Type part number suitable cable Note

BNC-J4	0811-6503	4	
BNC-J5	0811-6507	5	

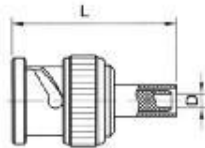

Type	part number	suitable cable	L	D	Note
BNC-J3Y	0811-6501	3	27	Φ1.6	
BNC-J4Y	0811-6504	4	25.8	Φ2.3	
BNC-J5YA	0811-6509	5	27.8	Φ3.1	
BNC-J5YA-1	0811-6510	5A	27.8	Φ3.1	

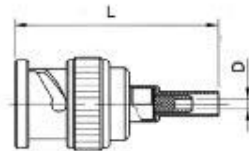

Type	part number	suitable cable	L	D	Note
BNC-J3YA	0811-6502	3	28.3	Φ1.6	
BNC-J4YA	0811-6506	4	29.8	Φ2.3	
BNC-J5Y	0811-6508	5	30.5	Φ3.1	

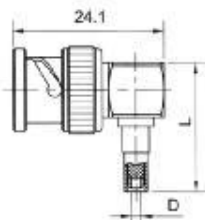

Type	part number	suitable cable	L	D	Note
BNC-JW3Y	0831-6501	3	20.6	Φ1.6	
BNC-JW4Y	0831-6502	4	24	Φ2.3	
BNC-JW5Y	0831-6504	5	26	Φ3.1	
BNC-JW5YA-1	0831-6506	5A	26	Φ3.1	

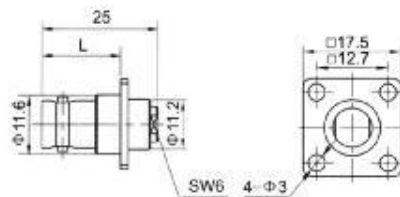

Type	part number	suitable cable	L	Note
BNC-KF3	0821-1501	3	15.6	
BNC-KF3A	0821-1502	3	17.1	

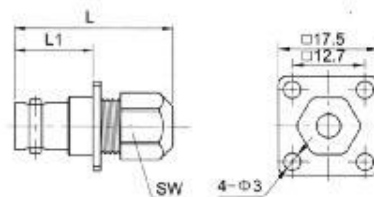

Type	part number	suitable cable	L	L1	SW	Note
BNC-KF4	0821-1506	4	29.8	14.6	10	
BNC-KF5	0821-1508	5	29	15.6	12	

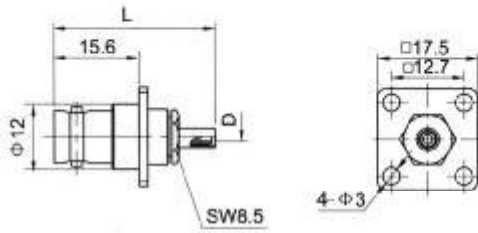

Type	part number	suitable cable	L	D	Note
BNC-KF3Y	0821-1504	3	29.3	1.6	
BNC-KF4Y	0821-1507	3	32.7	2.3	
BNC-KF5Y	0821-1509	5	34.7	3.1	

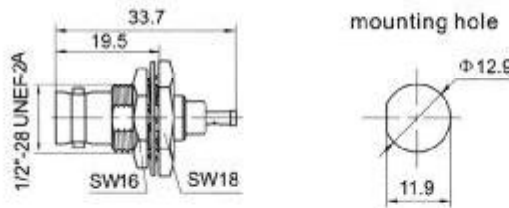

Type	part number	suitable cable	Note
BNC-KY0.8C	0821-2502	0.8	

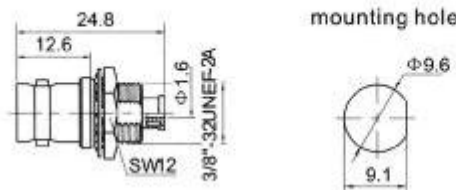

Type	part number	suitable cable	Note
BNC-KY0.8D	0821-2503	0.8	

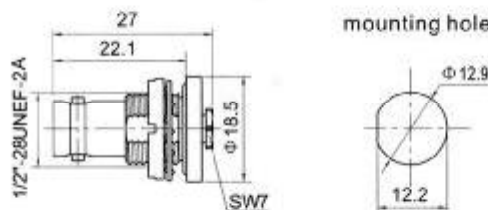

Type	part number	suitable cable	Note
BNC-KY2	0821-2504	2	
BNC-KY3A	0821-2509	3	

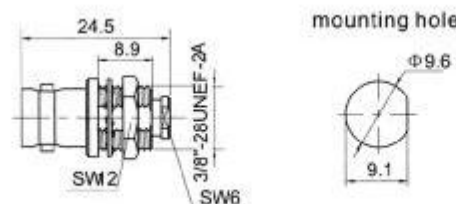

Type	part number	suitable cable	Note
BNC-KY3	0821-2508	3	

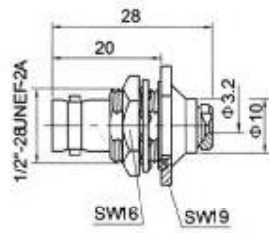

mounting hole

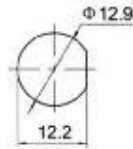

Type	part number	suitable cable	Note
BNC-KY3-1	0821-2510	3	

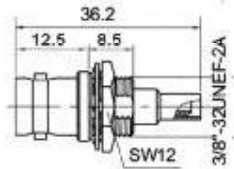

mounting hole

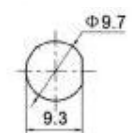

Type	part number	suitable cable	Note
BNC-KY3YA	0821-2513	3	

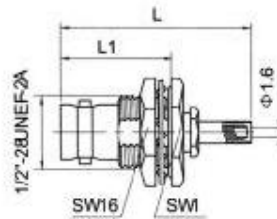

mounting hole

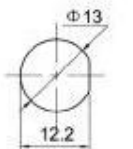

Type	part number	suitable cable	L	L1	SW1	Note
BNC-KY3YC	0821-2515	3	29.5	18.7	19	
BNC-KY3YE	0821-2516	3	30	20.2	17	

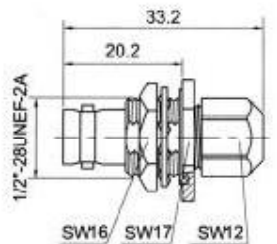

mounting hole

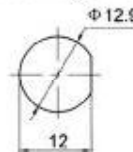

Type	part number	suitable cable	Note
BNC-KY4A	0821-2520	4	

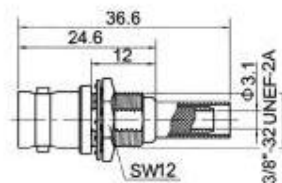

mounting hole

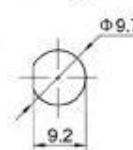

Type	part number	suitable cable	Note
BNC-KY5YB	0821-2519	5	

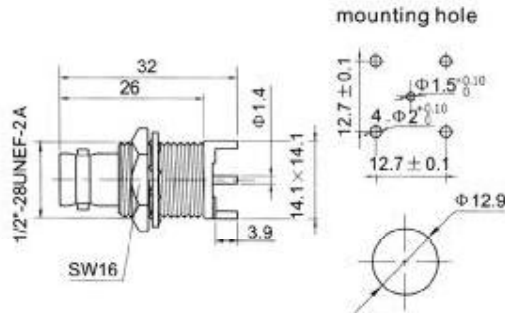

Type	part number	Note
BNC-KHD1	0821-5802	

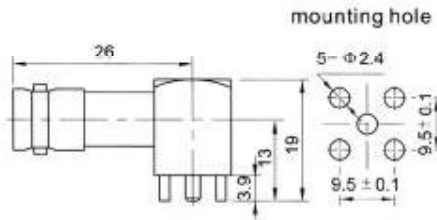

Type	part number	Note
BNC-KWHD	0841-5801	

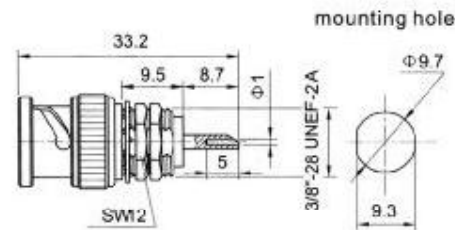

Type	part number	Note
BNC-JY1	0831-2902	

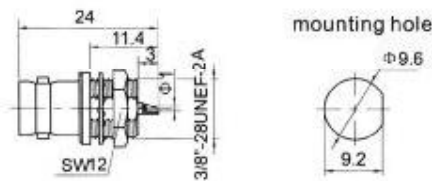

Type	part number	Note
BNC-50KY	0821-2901	

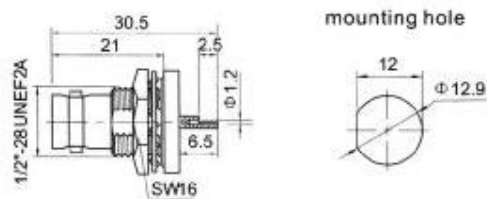

Type	part number	Note
BNC-KYD	0821-2801	

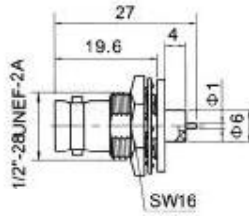

Type part number	Note
BNC-KYFD 0821-7802	



mounting hole

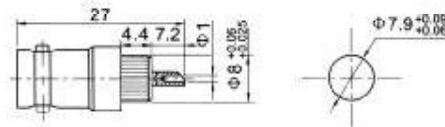

Type part number	Note
BNC-KP 0821-3901	

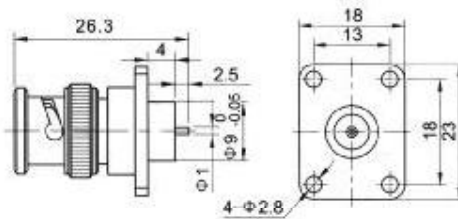

Type part number	Note
BNC-JFD1 0811-0001	

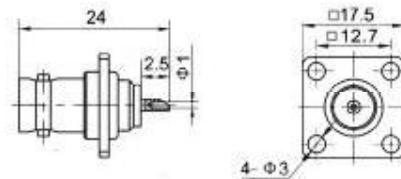

Type part number	Note
BNC-KF 0821-1901	

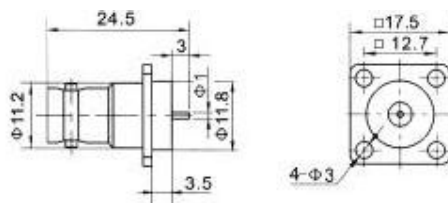

Type part number	Note
BNC-KFD 0821-0001	

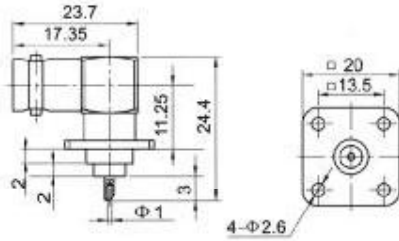

Type	part number	Note
------	-------------	------

BNC-KWF	0841-1901	
---------	-----------	--

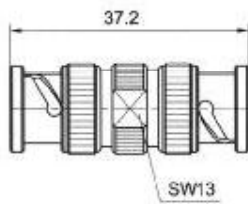

Type	part number	Note
------	-------------	------

BNC-JJ	0801-6901	
--------	-----------	--

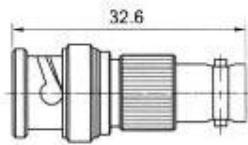

Type	part number	Note
------	-------------	------

BNC-JK	0801-6903	
--------	-----------	--

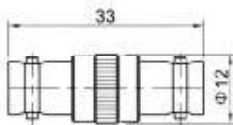

Type	part number	Note
------	-------------	------

BNC-KK	0801-6905	
--------	-----------	--

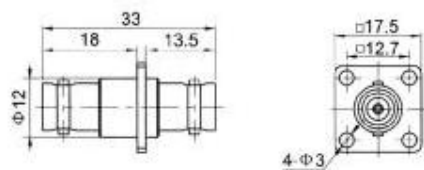

Type	part number	Note
------	-------------	------

BNC-KFK	0801-1901	
---------	-----------	--